

ThinkPower
smart energy solution for your family



ThinkPower

User Manual

- Installation
- Operation
- Maintenance



Three Phase Hybrid Inverter

- EPH4KTL ○ EPH5KTL ○ EPH6KTL
- EPH8KTL ○ EPH10KTL ○ EPH12KTL

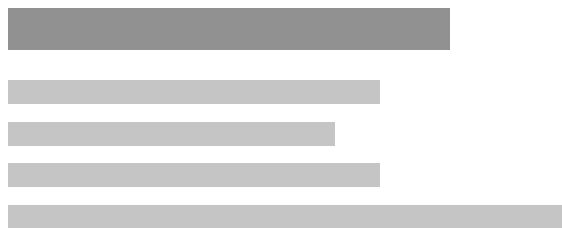

Contents

1 Introduction..... 1

- 1.1 Safety Symbols &Warnings.....1
 - 1.1.1 Symbols Explanation.....1
 - 1.1.2 SAFETY WARNING.....2
- 1.2 System Diagram.....3
- 1.3 Operation Modes Introduction.....3
 - 1.3.1 General mode(Default).....3
 - 1.3.2 Battery backup mode.....4
 - 1.3.3 Micro-grid mode.....4
 - 1.3.4 Peak shaving and valley filling mode.....4

2 Installation..... 6

- 2.1 Unpacking and Checking.....6
- 2.2 Unacceptable Installations.....6
- 2.3 Mounting.....7
 - 2.3.1 Requirements For Mounting.....7
 - 2.3.2 Mounting The Inverter.....8
- 2.4 Electrical Connection.....9
 - 2.4.1 System Wiring Diagram.....9
 - 2.4.2 Overview Of The Electrical Connecting Part.....10
 - 2.4.3 PV Connection.....10
- 2.5 Battery Connection.....11
- 2.6 DRED & RS485 Connection13
- 2.7 Grid & EPS Connection14
- 2.8 Power key and Declaration for EPS Loads15
- 2.9 Instructions on EPS mode15
- 3.0 Smart meter connection.....16

3 Operating of the Inverter.....17

- 3.1 LED and LCD Display.....17
- 3.2 Monitoring System.....19
 - 3.2.1 Software acquisition.....19
 - 3.2.2 WiFi Configuration.....19
 - 3.2.3 Monitoring and Setting.....20
 - 3.2.4 ESS Working Modes Setting Instruction21

4 Trouble Shooting.....26

5 Technical Data.....29

1 Introduction

1.1 Safety Symbols & Warnings

EPH series hybrid inverters are designed, manufactured and tested as per international safety standards. However, as an electrical and electric product, it must be installed, operated and maintained strictly according to related safety notices.

If you have any problems, please contact the nearest service center or authorized dealer. Please DO NOT install or repair the product by anyone who is not qualified by local authority.

We are not responsible for any damage or loss caused by misuse or misunderstanding of the information in the manual.

1.1.1 Symbols Explanation



Inverter will be touchable or operable after minimum 10 minutes after totally disconnected, in case of any electrical shock.



Danger of high voltage and electric shock!



Danger of hot surface and burn injury!



Earth line!



The wasted products must be sent to the authorized collecting center!



Refer to the operating instructions.

1.1.2 SAFETY WARNING



Warning

The inverter must be installed according to the local standard and related standard for an electrical enterprise. Please follow the instructions in this manual to use and operate the inverter.



Danger

Keep the PV array covered and the DC circuit breaker OFF. High voltage will be generated by PV array exposed under sunshine. All the cables must be connected firmly.



Danger

PV negative(PV-) and battery negative(BAT-) on inverter side are not grounded as default design. Connecting PV- or BAT- to ground are strictly forbidden.



Danger

- High voltage is a hazard, make sure the system device away from children.
- Any touch with the device or terminal may cause electric shock or fire. Please follow all the safety instructions.
- A damage device or system fault may cause electric shock. Make sure that you have checked the package and the device before installation to avoid unnecessary damage or loss.



Caution

Be aware of the hot surface while the device is running.



Warning

Do not open inverter cover or change any components without our authorization, otherwise the warranty commitment of the inverter will be invalid.

1.2 System Diagram

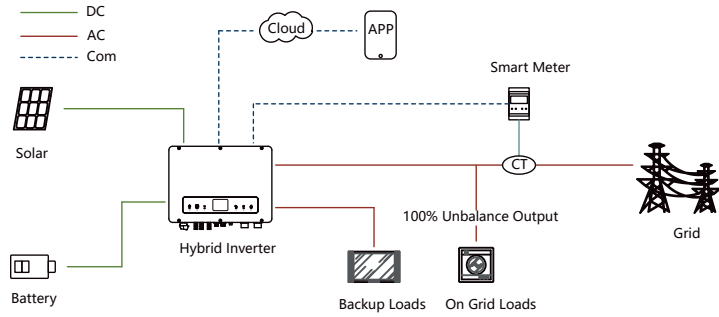

Fig.1.2

1.3 Operation Modes Introduction

EPH system normally has the following operation modes based on your configuration and layout conditions.

1.3.1 General mode(Default)

The default is General mode, and there are mainly two common application scenarios as shown below:

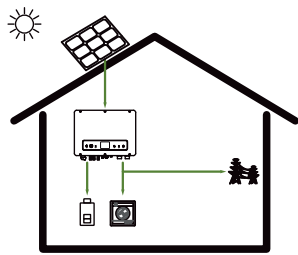

Fig:1.3.1(A)

A) When there is sufficient sunlight, it will give priority to supply power to the loads, charge the battery with excess, and then merge the excess into the grid.

B) When there is no sunlight, the battery supplies power to the loads.

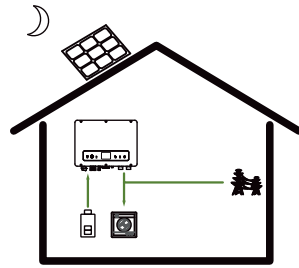

Fig:1.3.1(B)

1.3.2 Battery backup mode

In this mode, it is necessary to ensure that the battery is charged regardless of whether there is photovoltaic or not.

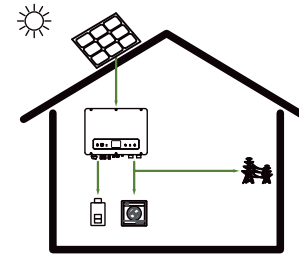

Fig:1.3.2(A)

A) When there is sufficient sunlight, it will give priority to supply power to battery, supply power to loads, and then merge the excess into the grid.

B) When there is no sunlight, it will get power from grid to charge battery fully.

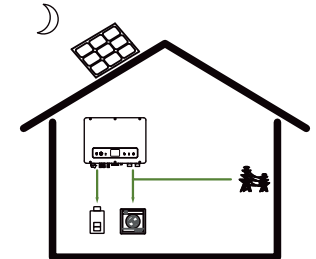

Fig:1.3.2(B)

1.3.3 Micro-grid mode

Suitable for non-grid scenarios

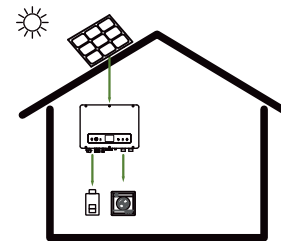

Fig:1.3.3(A)

A) When there is sufficient sunlight, it will give priority to supply power to the loads, charge the battery with excess.

B) When there is no sunlight, the battery supplies power to the loads.

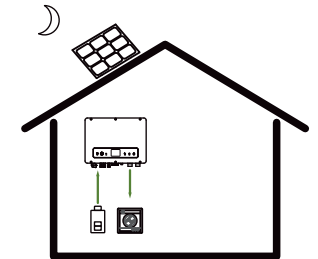

Fig:1.3.3(B)

1.3.4 Peak shaving and valley filling mode

According to the difference of electricity price, a day can be divided into three periods: peak, flat and valley.

1.3.4.1) In the valley level, the grid and PV charge the batteries.(Fig:1.3.4.1)

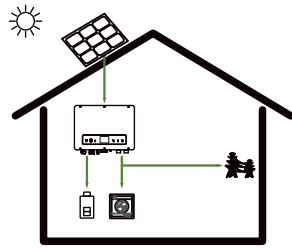

Fig:1.3.4.1

1.3.4.2) In the flat stage,if the PV is sufficient,the battery can be charged(Fig:1.3.4.2A); if the PV is insufficient, Priority is for loads(Fig:1.3.4.2B).

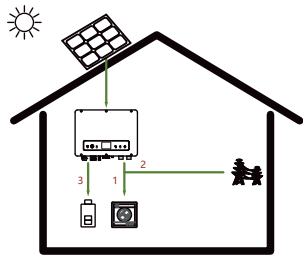

Fig:1.3.4.2A

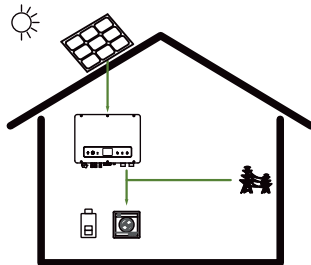

Fig:1.3.4.2B

1.3.4.3) In the peak level.

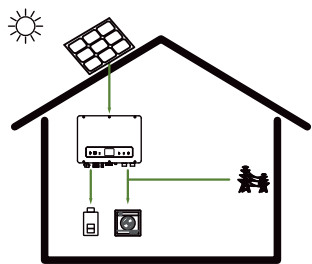

Fig:1.3.4.3(A)(PV is sufficient)

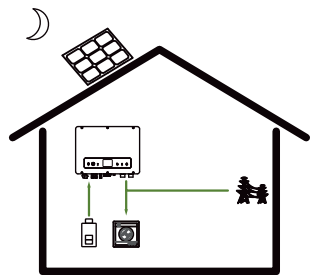

Fig:1.3.4.3(B)(PV is insufficient)

2 Installation

2.1 Unpacking and Checking

On receiving the inverter, please check before installation to make sure all the components as below are not missing or damaged.



2.2 Unacceptable Installations

Please avoid the following installations, which will damage the system or the inverter.

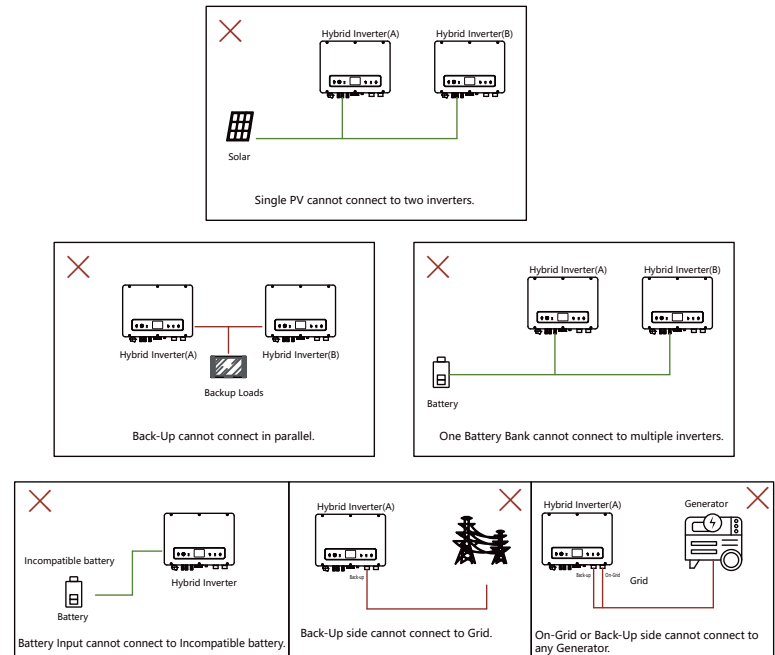

2.3 Mounting

2.3.1 Requirements For Mounting

※ The installation of the inverter should be protected under shelter from direct sunshine or any bad weather conditions as shown below:

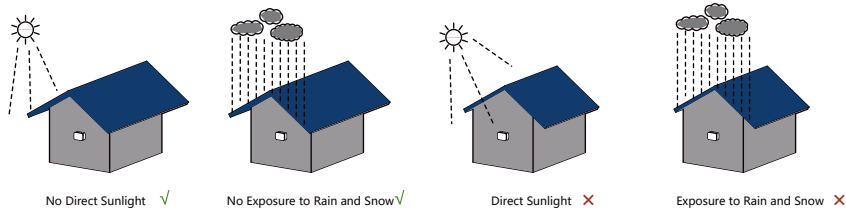

Fig.2.1

※ The inverter should be installed in a cool & dry place with temperature from -25°C to 60°C (High ambient temperature will cause the inverter's power derating).

※ The inverter LCD should be leveled with eyes and with enough space in the front for inspection.

※ The inverter should be installed on a vertical wall or within 15° at most if backwards to the wall

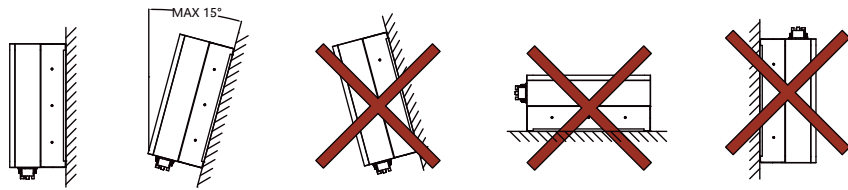

Fig.2.2

※ To avoid burning and electric shock, the inverter should be installed beyond reach of children.

※ Make sure the installation position does not shake.

※ Leave enough space around the inverter as shown below:

Position	Min.Size(CM)
Front	40CM
Lateral	40CM
Top	40CM
Bottom	50CM

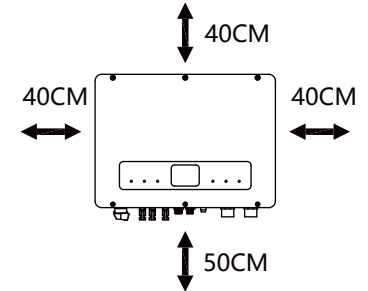

Fig.2.3

2.3.2 Mounting The Inverter

Step 1: Use the positioning the cardboard as template to drill 4 holes on walls.

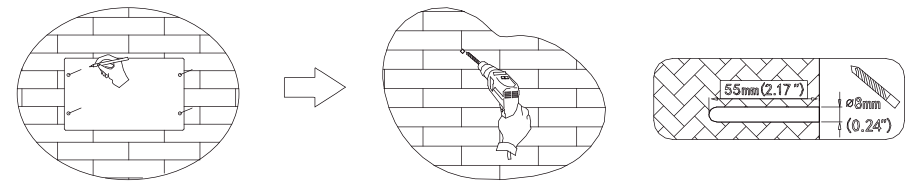

Fig.2.4

Step 2: Fix the trapping screws to the wall tightly.

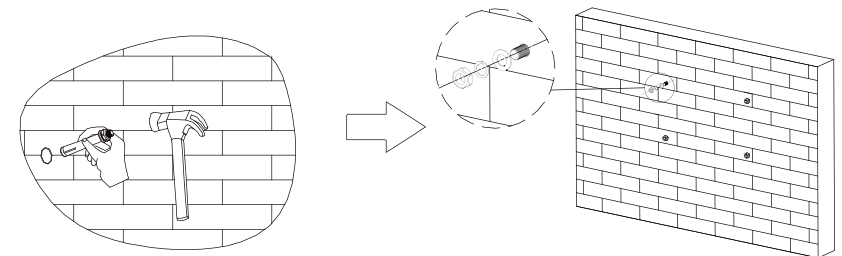

Fig.2.5

Step3: Lift and hang the inverter on the wall,lock the nuts, and fix the machine.

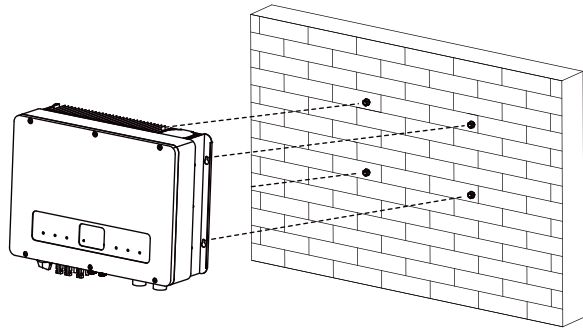

Fig.2.6

2.4 Electrical Connection

2.4.1 System Wiring Diagram

General wiring diagram of EPH series hybrid inverter.

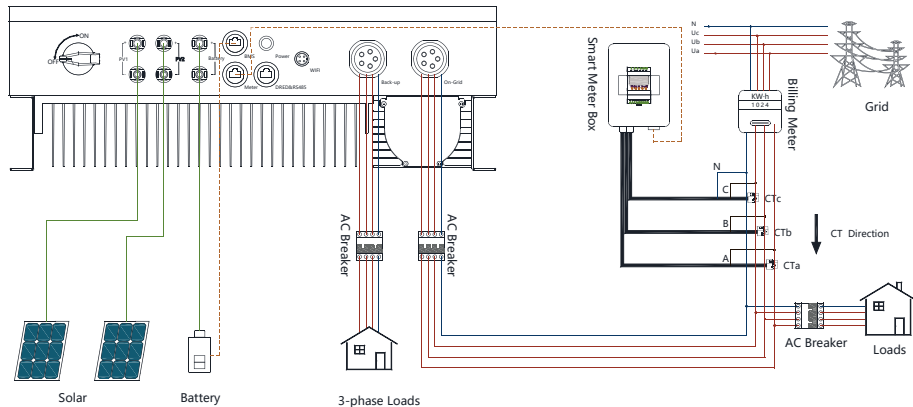

Fig.2.7

2.4.2 Overview Of The Electrical Connecting Part

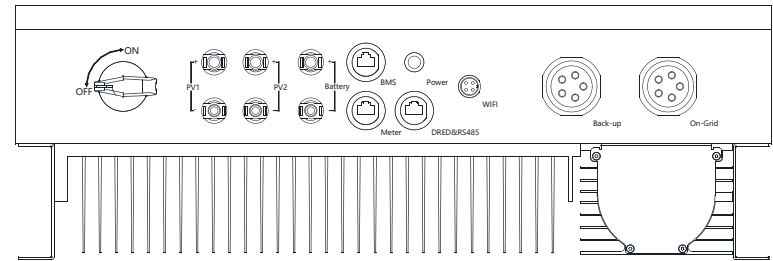

Fig.2.8

2.4.3 PV Connection

Before connecting PV panels/strings to inverter, please make sure:

- 1) Use the right PV connectors in the accessory box.
- 2) The voltage, current and power ratings of the PV strings are within the allowable range of the inverter. Please refer to the Technical Data Sheet for voltage and current limits.
- 3) Make sure the PV switch of the inverter is in the "OFF" position during wiring.
- 4) PV strings could not connect to EARTH conductor.

STEP1:

Assemble the PV connectors from the accessory box.(PV cable must be firmly crimped into connectors)

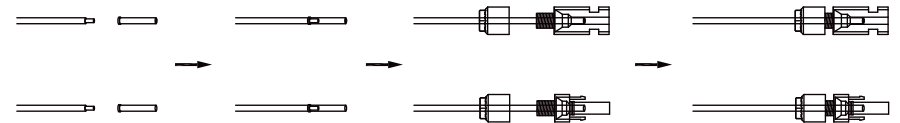

Fig.2.9

STEP2:

Connect the PV connectors to the inverter. There will be a click sound if connectors are inserted correctly into PV plugs.

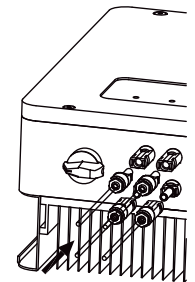

Fig.2.10

2.5 Battery Connection

Battery connection diagram

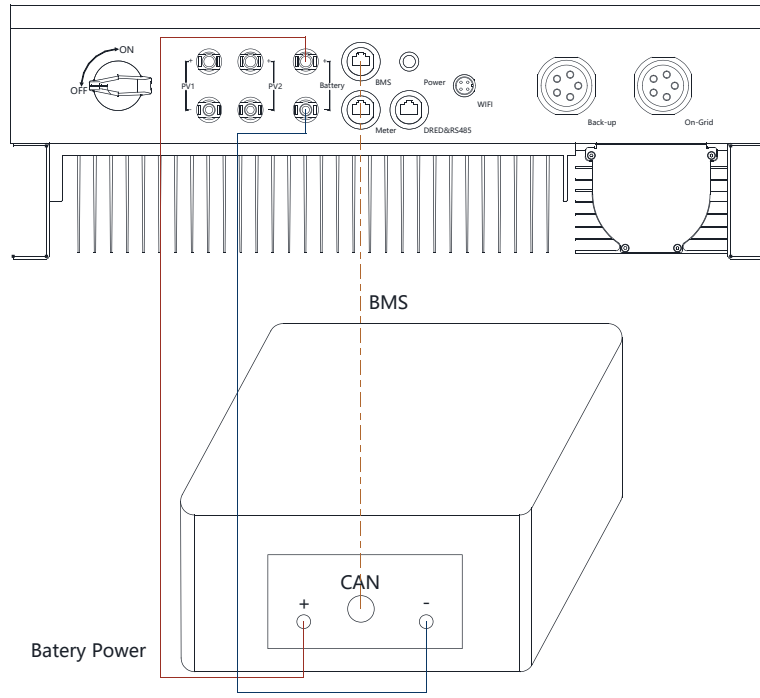

Fig.2.11

- 1) Use the right BAT connectors in the accessory box.
- 2) Choose 4 to 6 mm²(AWG 10) tin-plated cable to connect the battery and the inverter.
- 3) Make sure battery switch is off and battery nominal voltage meets EPH series inverter's specification before connecting battery to inverter.

STEP1:

Assemble the battery connectors from the accessory box.(battery cable must be firmly crimped into connectors)

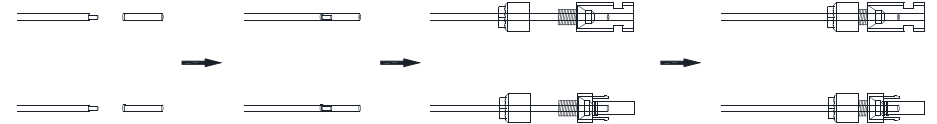

Fig.2.12

STEP2:

Connect the battery connectors to the inverter. There will be a click sound if connectors are inserted correctly into battery plugs.

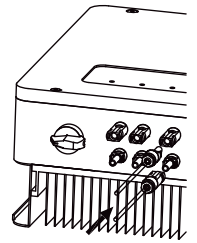

Fig.2.13

STEP3:

Connect the BMS cable between battery and inverter, insert the RJ45 connector with water-proof cap into the port marked "BMS" on inverter and fasten the cap. Then insert the other end of the cable into the battery port.



Position	Color	Signal Name
1	Orange&white	485_A2
2	Orange	NC
3	Green&white	485_B2
4	Blue	CAN_H
5	Blue&white	CAN_L
6	Green	NC
7	Brown&white	NC
8	Brown	NC

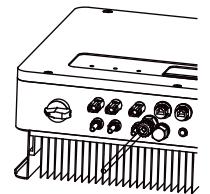

Fig.2.14

2.6 DRED&RS485 Connection

DRED cable connection diagram

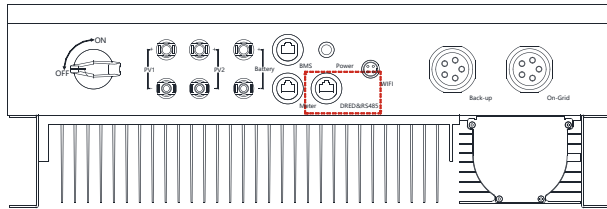

Fig 2.15

The RJ45 socket pin assignments for DRED as follows:



Position	Color	Min.Size(CM)	Function
1	Orange&white	485_A1	RS485 or EMS
2	Orange	485_B1	
3	Green&white	DRM 1/5 or DI_1	DRED or RCR
4	Blue	DRM 2/6 or DI_2	
5	Blue&white	DRM 3/7 or DI_3	
6	Green	DRM 4/8 or DI_4	
7	Brown&white	COM/DRM0 or REF_1	
8	Brown	REFGEN or REF_2	

Fig 2.16

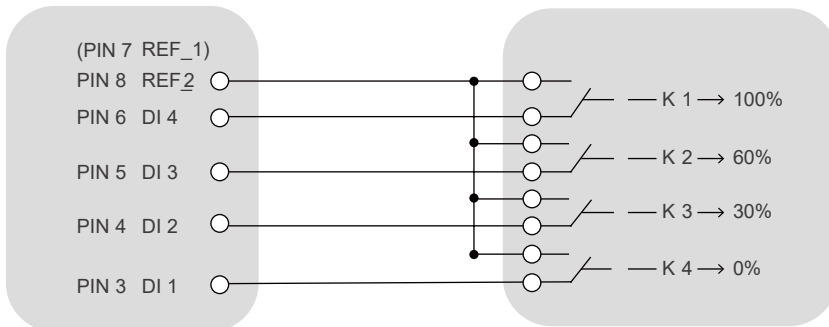

Fig 2.17

The inverter shall detect and initiate a response to all supported demand response commands, demand response modes are described as follows:

Mode	Requirement
DRM 0	Operate the disconnection device
DRM 1	Do not consume power
DRM 2	Do not consume at more than 50% of rated power
DRM 3	Do not consume at more than 75% of rated power AND Source reactive power if capable
DRM 4	Increase power consumption(subject to constraints from other active DRMs)
DRM 5	Do not generate power
DRM 6	Do not generate at more than 50% of rated power
DRM 7	Do not generate at more than 75% of rated power AND Sink reactive power if capable.
DRM 8	Increase power generation(subject to constraints from other active DRMs)

2.7 Grid & EPS Connection

Use the AC connectors from accessory box for grid and EPS connection. An external AC breaker(32A) is needed for on-grid connection to isolate from grid when necessary .

STEP1:

Assemble the grid connector. Follow the markings on the connectors, make sure 3L/N/PE lines are connected correctly.

Note: Pin 1 connect to grid phase A, pin 2 connect to phase B and pin L to phase C.

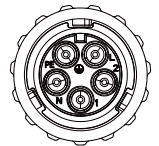

Fig.2.18

The similar way to assemble the EPS connector, pin1, pin2 and pin L are live lines, pin N is neutral.

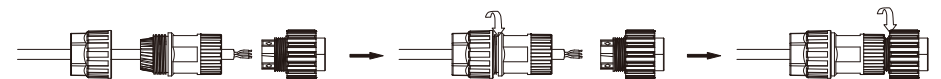

Fig.2.19

STEP2:

Connect the grid connector and the EPS connector to the inverter. Just follow the markings on the inverter to connect them correctly.

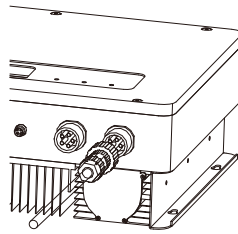

Fig.2.20

2.8 Power key and Declaration for EPS Loads

The power button on the rear panel is only used for EPS function.

※When mains power does not exist and EPS function is enabled, press and hold for 3 seconds, the inverter will enter backup mode;

※When inverter operates in backup mode, press and hold for 3 seconds, inverter will exit backup mode;

※When inverter gives an alarm and shutdown in backup mode, press and hold for 3 seconds, inverter will clear alarm.

Accepted loads as blow;

※Inductive load: a non-frequency conversion air conditioner within 1.5P can be connected to EPS side. Two or more may cause EPS output unstable.

Do not connect 3-phase inductive load(like motor) without Neutral line to EPS side.

※Capacitive load: Total power $\leq 0.6 \times$ nominal power of model.

2.9 Instructions on EPS mode

2.9.1 No load can be connected to both the EPS and on grid ports, any failure caused by this will not be covered by the warranty.

2.9.2 In EPS mode, the sum of the load power shall not exceed the maximum off-grid power indicated in the specification of the corresponding model.

2.9.3 Please contact a professional electrician for wiring inspection before EPS running, non-professional operation is not recommended.

2.9.4 Half-wave loads are not supported. There are certain electrical devices or systems in household loads that operate only during the positive half cycle of the supply voltage. For example, the smallest gear of a hair dryer. These non-complete sine wave devices have the following hazards:

1)※ Damage to the inverter: The main impact of half-wave loads on inverters is damage to their voltage stability and thermal damage. Because the peak current generated by half-wave load is short-lived, but it is very easy to cause thermal damage to the internal components of the inverter. Long-term half-wave load operation will reduce the life and reliability of the inverter.

2)※ Deterioration of the load: Half-wave loads have a bad impact on the load itself, e.g. for motor loads, half-wave loads can cause motor oscillations and defects. At the same time, half-wave loads also tend to cause incidental noise and EMI interference, affecting the performance and reliability of the system.

2.9.5 In the use of ATS/DTS switching devices, it is not permitted to connect grid-connected wires from the inverter's on grid port to the ATS output.

3.0 Smart meter connection

The RJ45 socket pin assignments for Meter as follows:



Position	Color	Min.Size(CM)
1	Orange&white	NC
2	Orange	NC
3	Green&white	485_B
4	Blue	NC
5	Blue&white	NC
6	Green	485_A
7	Brown&white	485_B
8	Brown	485_A

Fig.2.21

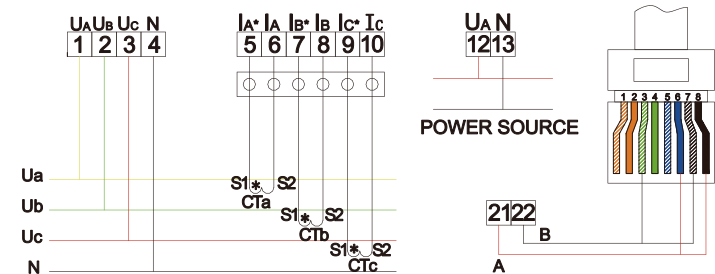

Fig.2.22

Please Refer to the connection instructions in the meter box for connection

3 Operating of the Inverter

3.1 LED and LCD Display

The LED indicators are shown as blow:

LED	Status	Explanation
SYSTEM	ON	System is powered up
	OFF	System is not powered up
GRID	ON	Grid is normal
	OFF	Grid loss
	FLASH	Grid is abnormal
EPS	ON	Inverter in offline mode, EPS is active
	OFF	Inverter is not in offline mode
COM	ON	WIFI module connected
	OFF	WIFI module not connected
METER	ON	Smart meter communication OK
	OFF	Smart meter communication fail
FAULT	ON	Alarm occurred and inverter stop work
	OFF	No Alarm
	FLASH	Alarm occurred but inverter still work

The LCD display shows the detailed information of the inverter

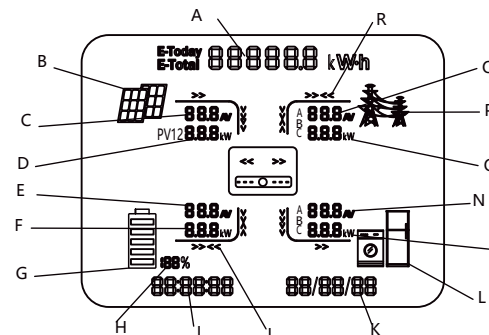

Position	Description
A	It indicates the power output amount of total and today alternately. Unit: kWh or MWh
B	PV panels indicator
C	PV1,PV2 panels parameters. Voltage and current are displayed alternately.
D	Total PV power
E	Battery parameters. Voltage and current are displayed alternately.
F	Battery power
G	Battery indicator
H	SOC of battery
I	Current time
J	Power flow array of battery. When it towards battery, it means charging; when it towards inverter,it means discharging.
K	Default as current date. When an error occurs, fault code will be displayed alternately.
L	Loads indicator
M	Loads power consumption of each phase
N	Load parameters. Voltage and current of each phase are displayed alternately.
O	Power export or import of each phase
P	Grid indicator
Q	Grid parameters. Voltage and current of each phase are displayed alternately.
R	Power flow array of load

3.2 Monitoring System

PowerView monitoring platform support both APP and web monitoring, user can monitor detailed running information like generating capacity, system data, and send command, set parameters at same time.

3.2.1 Software acquisition

APP: Download APP by searching 'PvPro' in Google Play or Apple App Store.

Web: <https://pv.inteless.com>

3.2.2 WiFi Configuration

Plug in the WiFi module, power up inverter with PV or Battery, the WiFi module red LED will turn on, configure WiFi follow steps below.

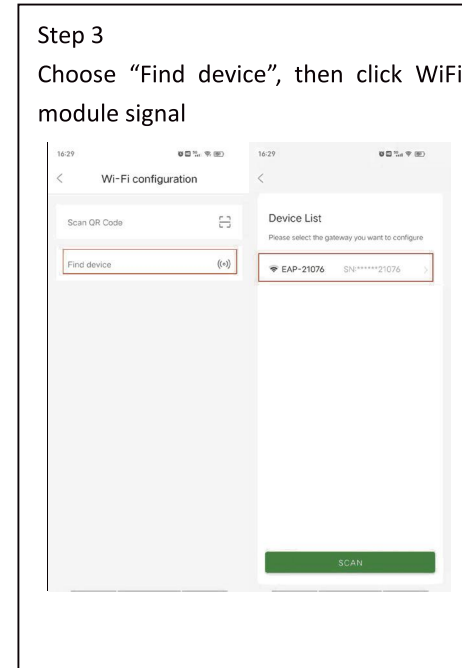
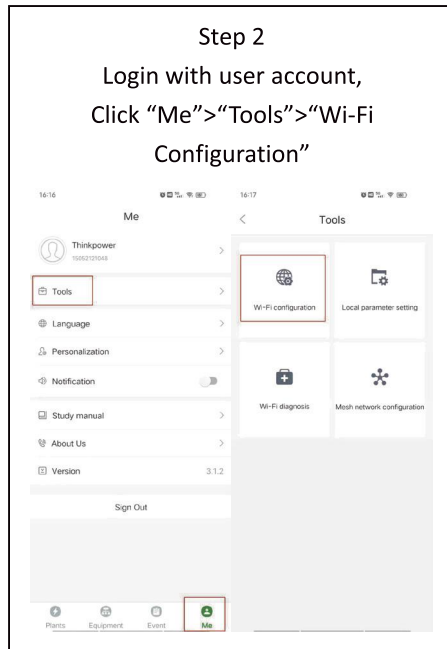
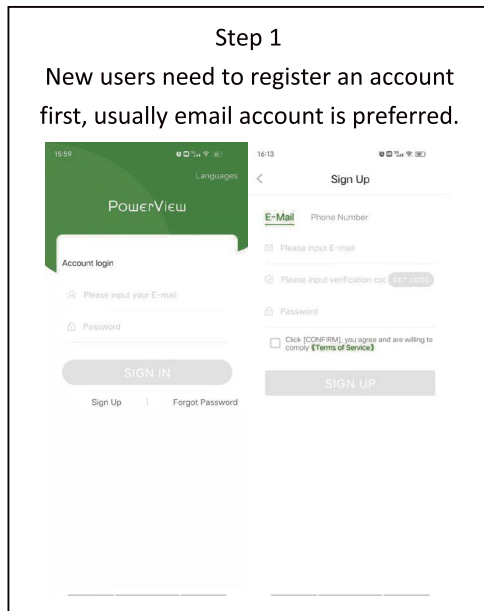

3.2.3 Monitoring and Setting

Both web and APP are available, this part shows monitoring and setting on web page.

The default setting is the most common, and users generally do not need additional settings.

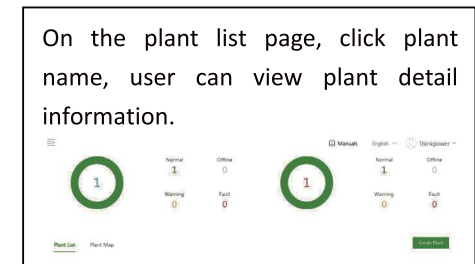
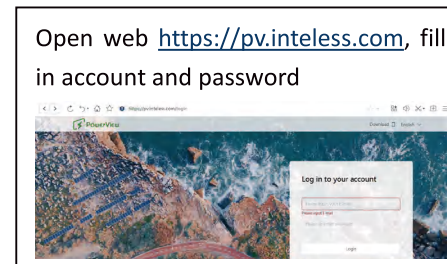

On the plant information page, click “Equipment”>”Parameter Setting”, Users can set the inverter according to their needs

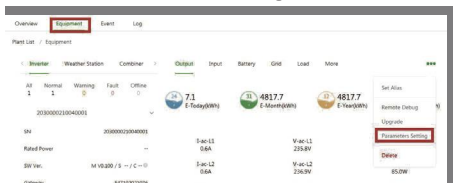

3.2.4 ESS Working Modes Setting Instruction

- Working mode selection

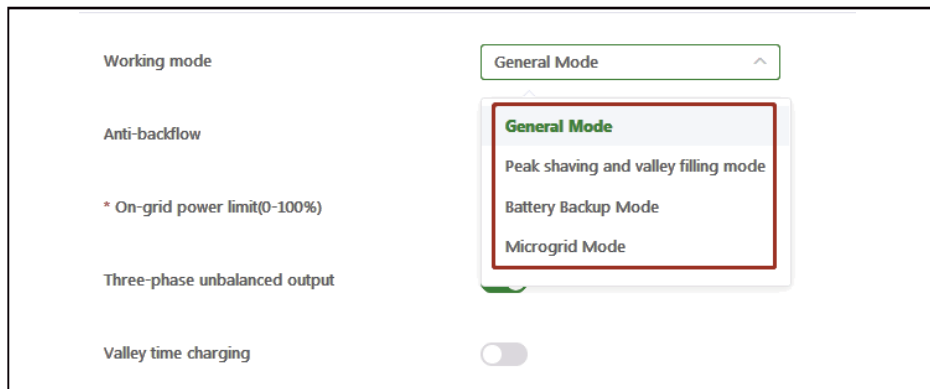

The energy storage inverter provides four working modes to meet the needs of users in different applications, namely

Automatic mode (default), peak shaving and valley filling mode, battery backup mode and Microgrid mode.

Automatic mode: the automatic mode can maximize the self use rate of photovoltaic power generation, and achieve the goal of not consuming grid power as much as possible within the regulation range of the energy storage system. The load at any time is the first priority, and charging is the second priority. When the battery is full, selling power to the grid is the third priority. When the photovoltaic power is less than the load power, the battery will automatically discharge to avoid consuming the power of the grid. The automatic mode can meet the application needs of most families. It is generally recommended that users keep the automatic mode setting.

Peak shaving and valley filling mode: when the battery capacity of the energy storage system is small, the user's power consumption is relatively large, and there is a big peak valley electricity price difference in the user's region, the user can choose whether to adopt the peak shaving and valley filling mode according to his own power consumption. It should be noted that after setting the peak shaving and valley filling mode, the user must correctly set the peak valley period at the bottom of the page, and the period outside the peak valley period is the flat period. Compared with the automatic mode, the self utilization rate of photovoltaic power generation in the energy storage system will be reduced. During the peak period, the priority of load & charging & selling power is the same as that in the automatic mode; During the valley period, if the photovoltaic power is less than the load power, the battery will not discharge. At this time, the load consumes the power of the grid, and the user can set whether to charge the battery from the grid during this period; In the flat section, the system only charges the battery with excess power when the photovoltaic power is greater than the load power, and the battery will not discharge or get charged from the grid.

Battery backup mode: in areas with unstable power grid, this mode can try to meet the power demand of users during power loss. At the bottom of the setting page, you can set whether to charge the battery from the grid in the battery backup mode.

Microgrid mode: applicable in areas without power grid.

● Power limit setting

Anti-backflow	<input type="checkbox"/>
* On-grid power limit(0-100%)	<input type="text" value="100"/>

Users can choose whether to turn on the on-grid power limit function after the battery is fully charged according to whether the local power grid company allows the photovoltaic power being exported to the power grid. This function is turned off by default. When the photovoltaic power is greater than the load power, the system will charge the battery. If the battery is full at this time, if the on-grid power limit function is turned off, the excess photovoltaic power will be sent to the power grid; If the on-grid power limit function is enabled, the system will adjust the amount of power sent to the grid according to the power limit percentage set by the user. For example, if the system is 10kW and the on-grid power limit is 0%, the power export is completely prohibited; If it is 50%, after the system is fully charged, the excess photovoltaic energy is allowed to send 5kW to the grid at most.

● Three phase unbalance setting

Three-phase unbalanced output	<input type="checkbox"/>
-------------------------------	--------------------------

In some countries or regions, such as the Czech Republic, three-phase billing meters charge independently on each phase. Users can choose whether to turn on the three-phase unbalanced output function. It should be noted that in most countries, three-phase billing meters are charged uniformly after three-phase summary, so it is not necessary to turn on this function, because the conversion efficiency of the inverter will be slightly reduced after turning on this function.

● Valley time charging

Valley time charging	<input type="checkbox"/>
* Valley time charging SOC(20-100%)	<input type="text" value="60"/>
* Valley time charging power(500-10000W)	<input type="text" value="3000"/>

This function is only effective when the user selects the peak shaving and valley filling mode, and it is generally not recommended to start it.

● Valley period & peak period

Valley period 1	<input type="checkbox"/>
Valley period 1 start hour	<input type="text" value="00:00"/>
Valley period 1 start minute	<input type="text" value="00:00"/>
Valley period 1 end hour	<input type="text" value="00:00"/>
Valley period 1 end minute	<input type="text" value="00:00"/>

Peak and valley periods are only effective when the user selects the peak cutting and valley filling mode. The system can set three Valley periods and three peak periods, and the periods cannot overlap.

●Peak time discharge

Peak time discharge mode Automatic power regulation ▾

* Peak time discharge power(500-10000W) 3000

The peak time discharge setting is only effective when the user selects the peak shaving and valley filling mode. During the peak time, the default setting is that the system automatically adjusts the discharge power according to the household power detected by the smart meter; If the smart meter is not installed, the user can select a fixed discharge power according to the approximate power consumption.

●Battery backup mode charging setting

Charging with grid in storage mode

* Storage mode charge SOC(20-100%) 40

* Storage mode charge power(500-10000W) 4000

The battery backup mode charging setting is only effective when the user selects the battery backup working mode. You can set whether to turn on the mains power to charge the battery, and the charging power and battery charging cut-off SOC.

4 Trouble Shooting

This part introduces the common fault and solving steps, provides troubleshooting methods and skills to the user, and helps the user identify and solve some common faults of the inverter.

Protection code	Description	Recommended solution
P001	PV over voltage protection	Check the configuration of the PV panels
P002	Battery over voltage protection	Check if battery volt larger than 600V
P003	Insulation resistance low	Check the insulation of PV panels
P004	Leakage current high	This error will reset itself.
P005	Over temperature protection	The inverter will recover automatically when the temperature gets lower.
P006	Bus voltage unbalance	The inverter will recover automatically.
P007	Bus voltage high	
P008	Bus voltage low	
P009	Grid and EPS are reversed	Check the connection of AC side. Make sure the grid and EPS load are connected to the ports on the inverter correctly.
P010	Grid relay open-circuit	Shut down and restart .If it still can't be auto-recover, please contact the service.
P011	Grid relay stick	
P012	On-grid mode bus soft start fault	
P013	MCU communication fault	Battery discharged to low level, it will recover after charged automatically
P019	Battery SOC low in on-grid mode	
P020	Battery SOC low in EPS mode	
P021	Battery voltage low	

P022	Battery open-circuit	Check the connection of battery and set right battery SOC in each mode. Check the battery for parameter settings.
P023	Battery SOC deadly low	
P024	BMS communication fault	Check the BMS communication cable and BMS protocol setting
P025	No time interval setting for Peak shaving and valley filling mode	Check inverter work mode setting
P026	Remote off	Inverter turn off through monitoring
P027	Smart meter communication fault	Check the communication cable for smart meter and meter protocol
P033	Grid voltage high	Check if grid fails or not connected well
P034	Grid voltage low	
P035	Grid frequency high	
P036	Grid frequency low	
P037	Islanding protection	
P038	Grid wave loss	
P039	DC injection high	The inverter will recover automatically.
P040	Utility not three phase	Check if grid cable well connected
P041	Phase sequence fault	Reverse connection order of L2 and L3 cable
P042	PLL error	The inverter will recover automatically.
P048	EPS overload	Decrease EPS loads to make sure the total loads power is lower than EPS nominal output power, press power key more than 3 seconds to clear alarm
P049	EPS output voltage high	Check if EPS over load, press power key more than 3 seconds to clear alarm
P050	EPS output voltage low	
P051	EPS mode bus soft start fault	
P052	Inv soft start fault	
P053	EPS load short circuit	

P059	Battery current limited	The inverter will recover automatically.
P060	Inv trip	
P061	Transient trip	
P062	Bus trip	

If you meet any problem that you cannot solve by yourself, please contact with your local distributor or our company.

5 Technical Data

Model	EPH4KTL	EPH5KTL	EPH6KTL	EPH8KTL	EPH10KTL	EPH12KTL
Input(PV)						
Max PV Power	6000W	7500W	9000W	12000W	15000W	15000W
Max PV Voltage	1000Vd.c					
MPPT voltage range	200~850Vd.c					
Max input current/per string	13A/13A					
Max input short circuit per MPPT	18A/18A					
Number of MPP trackers	2					
Strings per MPP tracker	1					
Battery Input						
Battery Type	Li-Ion					
Battery voltage range	130~700V					
Max charge/discharge current	25/25A					
Charge strategy for Li-Ion Battery	Self-adaption to BMS					
AC Output (On-Grid)						
AC nominal power	4000VA	5000VA	6000VA	8000VA	10000VA	12000VA
Max AC apparent power	5000VA	5500VA	7000VA	8800VA	11000VA	13200VA
Max output current	8A	10A	12A	15A	17A	20A
Nominal AC output	50/60Hz;400/350					
AC output range	45/55Hz;280~490Vac(Adj)					
Power factor	0.8leading~0.8laging					
Harmonics	<3%					
Grid type	3W/N/PE					
Three-phase unbalance output	0~100%					0~80%
AC Output (Back-up)						
Max AC apparent power	4000VA	5000VA	6000VA	8000VA	10000VA	10000VA
Norminal Output Voltage	400/380					
Norminal Output Frequency	50/60HZ					
Output THDV (@Linear Load)	<3%					

Efficiency						
Max conversion efficiency	98.0%	98.0%	98.2%	98.2%	98.2%	98.2%
European efficiency	97.3%	97.3%	97.5%	97.5%	97.5%	97.5%
MPPT efficiency	99.9%	99.9%	99.9%	99.9%	99.9%	99.9%
Safety and protection						
DC reverse-polarity protection	yes					
DC breaker	yes					
DC/AC SPD	yes					
Leakage current protection	yes					
Insulation Impedance Detection	yes					
Residual Current protection	yes					
Output short circuit protection	yes					
Bat reverse connection protection	yes					
General Parameters						
Dimensions (W/H/D)	555*445*205mm					
Weight	28kg					
Operating temperature range	-25°C~+60°C					
Degree of protection	IP65					
Cooling concept	Natural convection					
Topology	Transformerless					
Display	LCD					
Humidity	0~95%,No condensation					
Communication	Standard WiFi;GPRS/LAN(optional)					
BMS communication	CAN/RS485					
Meter communication	RS485					